



FOR CLAY TILES

UNIQUE ON THE MARKET

How you will benefit from our products

- » Universal replacement plate for **nearly** all types of roofing tile
- » Up to 60% reduction in roof connections and assembly materials
- » Suitable for high snow load (up to 1,500 kg)
- » Simplified warehousing
- » No mechanical cutting needed
- » Min rafter width from 36 mm with 6 mm wood screws or from 48 mm with 8 mm wood screws
- » RAILS can be height-adjusted thanks to pre-mounted clamp combination (for vertical rail installation, exchange with optional vertical clamp combination, item No. 11105-05)
- » Tried and tested rapid attachment system for rails
- » Just one tool needed: Torx TX40
- » Sealed by a riveted-on rubber collar in UV-resistant EPDM and raised edges to the plate
- » The recesses between the corrugations create areas of reduced wind, meaning water flows longitudinally downwards
- » With integrated snow and ice repeller
- » Installation with a single layer of battens or with crossbars

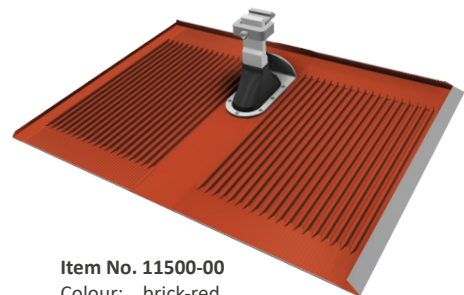

Item No. 11500-00
Colour: brick-red

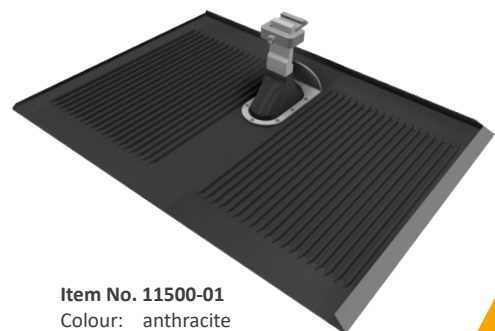

Item No. 11500-01
Colour: anthracite



*Our warranty conditions apply. These can be viewed at any time online at www.sl-rack.de

Dimensions

	a	b	c
Alpha-Plate	approx. 430 mm	approx. 156 mm	approx. 581 mm

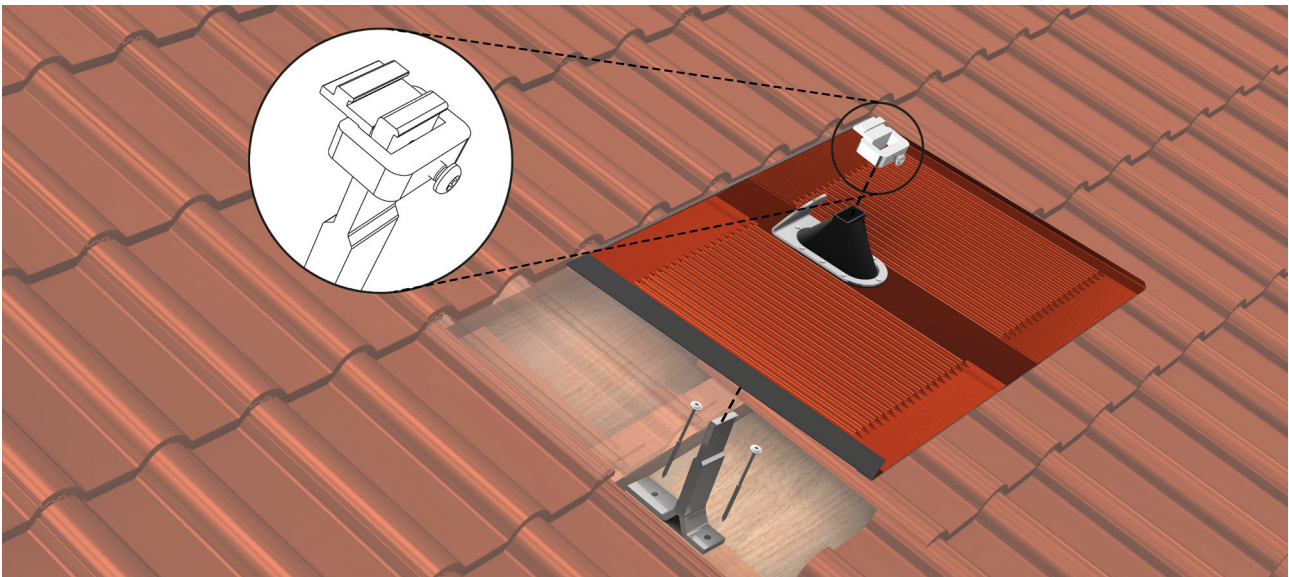
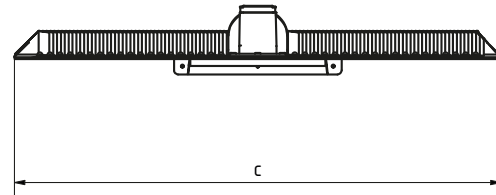
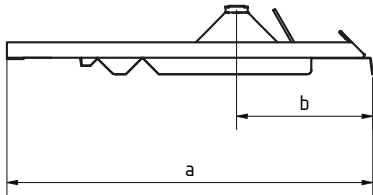

So your roof mounts sit perfectly: Check for suitability before installation!

- » Minimum inclination of the Alpha plate 3 %
- » To ensure a seal, the roof tiles need to be dry and free from dirt during installation
- » **The tile gauge should not be longer than the Alpha plate.**
- » **Roofing sheets with locking pyramids underneath and extremely pronounced corrugation / waves are not compatible**
- » **Pooling water is to be avoided:**
The attachment lugs of overlying tiles may need to be removed
- » Alpha plates may not be installed **directly** on top of each other
- » Special approval on consultation
- » For questions about tiles, visit sales@sl-rack.de

Accessories

» Alpha-Flex 120 Item No. 11512-00

- Mounting plate of the bracket
- Lateral displacement of the bracket for correction
- Additional mount for grounding
- Incl. Alpha-Flex bracket fixture

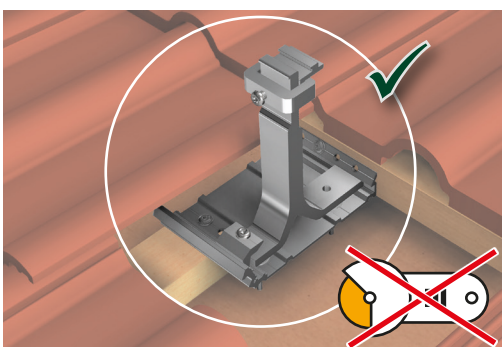
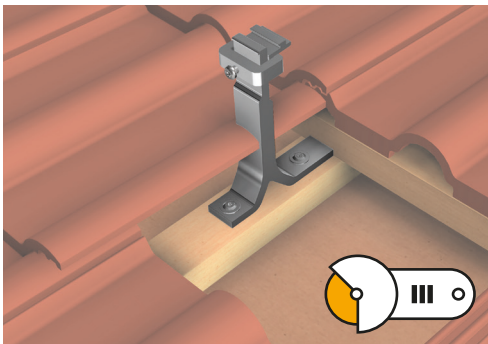

» Alpha-Flex 2000 Item No. 11501-2000

- Spans up to 2 rafters (if they have no clean area to attach the bracket or mounting plate)
- Better load distribution through the use of several brackets
- Lateral displacement of the bracket for correction
- Additional mount for grounding



**Optional vertical
clamp combination**
Item No. 11105-05



**Optional equipotential
bonding terminal for
SL Alu and Alpha-Flex**
Item No. 11101-20

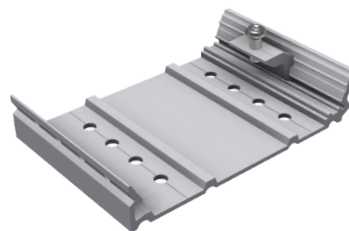

**Optional Alpha-Flex 120
mounting plate incl.
bracket fixture**
Item No. 11512-00



**Optional Alpha-Flex
bracket fixture**
Item No. 11501-02



**Optional rafter-
spanning strip
Alpha-Flex 2000**
Item No. 11501-2000



Alpha plate
assembly video

Assembly procedure

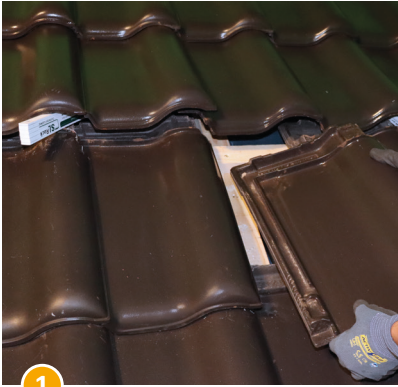

1 Remove the roofing at the area of installation (max. 3 tiles) and place the outer sections...



2 ...below the upper row so that the horizontal battens can be easily viewed and worked on.



3a With the long member upwards, place the bracket on the roofing batten (batten aids in orientation).

ALTERNATIVE ATTACHMENT WITH THE ALPHA-FLEX

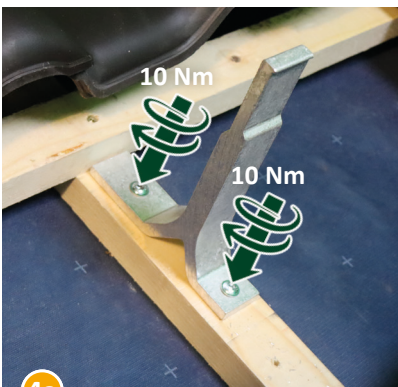

4a Attach the batten: fix in position by tightening the screws (min. 2 screws, 10 Nm).
Jump forward to step 10.

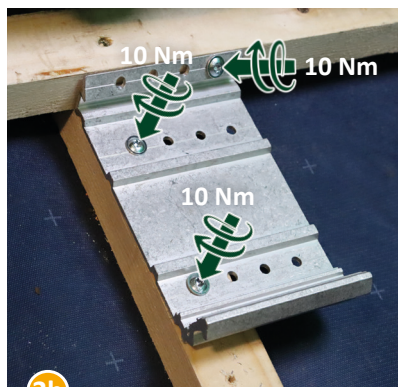

3b Position the Alpha-Flex with the slot upwards. Arrange it on the roofing batten so it sticks out to left or right and attach (min. 3 screws, 10 Nm).

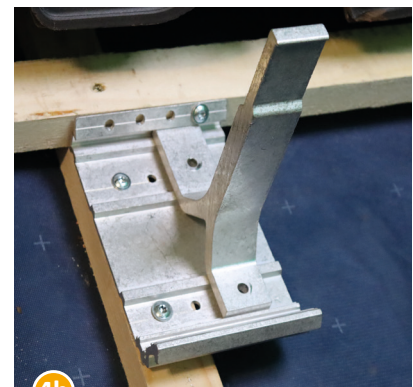

4b With the long member upwards, hook the bracket onto the upper slot of the Alpha-Flex.



5b Hook the Alpha-Flex bracket fixture...

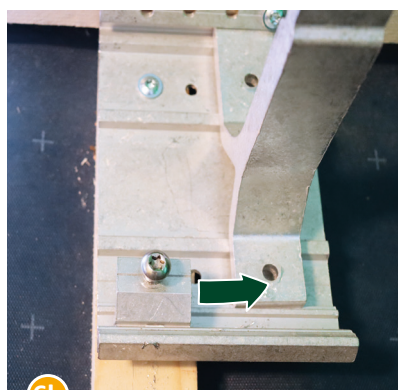

6b ...and arrange it centrally over the bracket.

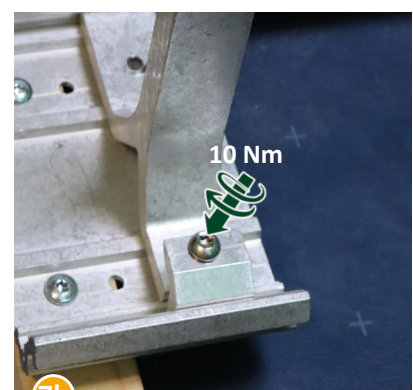

7b Fix it in place by tightening the screw (10 Nm).



Alpha plate
assembly video

Assembly procedure



8b

Optional: Phook the equipotential bonding clamp onto the bottom of the Alpha-Flex and fold it forwards.

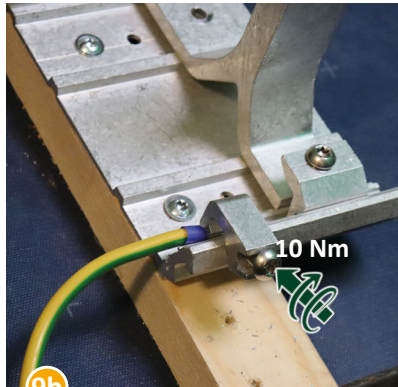

9b

Attach the equipotential bonding clamp: fix it in place by tightening the screw (10 Nm).



10

Determine the tile height (TH) to be compensated for.

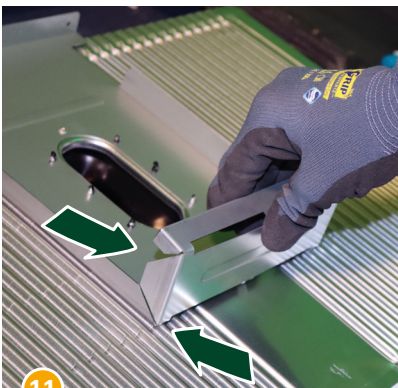

11

Set the height of the Alpha plate by unfolding the support plate on the rear to the suitable extent.

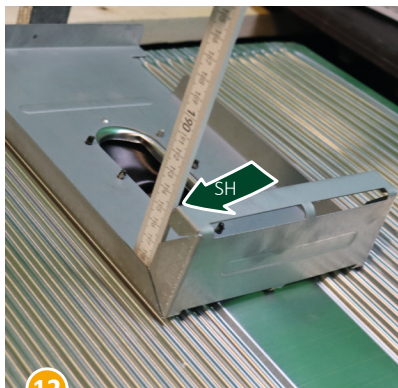

12

Tile height (TH) = Support plate height (SH).

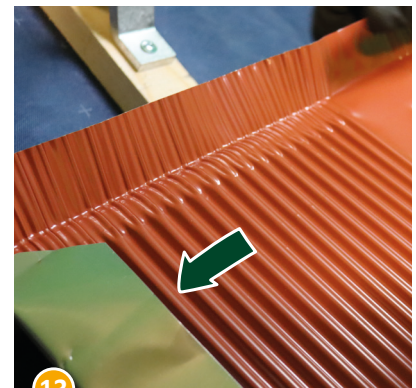

13

Orient the Alpha plate, making sure that carefree indentations do not lead to water pooling in the central and upper areas.



14

Set the upper edging of the plate slightly backwards to ensure full coverage of the upper lip.



15

Place the opening in the support plate over the upper horizontal batten and slot the Alpha plate with its riveted-on sealing collar over the bracket.



16

Completely remove the protective foil on the adhesive strip on the underside of the Alpha plate; **Make sure the area to be adhered to is clean, dust-free, and dry!**



Alpha plate
assembly video

Assembly procedure



Starting from the centre, push the plate tightly and firmly into shape...



...making sure, once again, that the central and upper areas do not lead to water pooling.



The clay tiles to be replaced may have attachment lugs:



Remove them.



Reassemble the roofing.



Additionally secure the sealing collar by means of a cable tie. To this end, seat the cable tie in the groove, place the locking end of the tie at one of the four corners of the collar, pull it tight and cut off the excess.



Replace the clamp combination on the bracket, place the crossbar on top, hook it in place, adjusting the height using the clamp combination on the bracket...

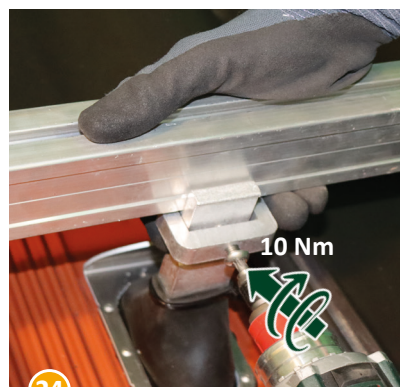

...and fix in place by tightening the screw (10 Nm).

Done!



Technical specifications

Material	Rolled sheet aluminium, rubber collar in EPDM, aluminium (bracket, clamp combination, snow or ice repeller) and galvanised steel (support plate)
Planning aids	SL-Rack configurator Solar.Pro.Tool .
Statics	The statics calculation takes place as per the current country-specific standards (EN 1991, EC1 for Germany). Depending on snow or wind loads or for large modules, it may be necessary to use more than the standard 4 attachment points. Please make sure to comply with the instructions of the module manufacturer contained in the installation manual. We do not assess the load-bearing capacity of the roof.

Your opinion is important to us!

Oberstes Ziel für uns ist es stets, Ihnen den Arbeitsalltag so gut es geht zu erleichtern. Deswegen ist es uns auch enorm wichtig, Ihr Lob, Ihre Kritik und auch Ihre Verbesserungswünsche zu erfahren.



SL Rack **Feedback**
[Write feedback >](#)



SL Rack **Website**
[Find out more >](#)



SL Rack **YouTube**
[View videos >](#)

Visit us at



The right to make technical alterations is reserved; no guarantee is given that the text is free from typographical errors.
As of 08/2022 V16